

IGBT in TO-247

Features

- 650V I_A , $V_{CE(sat)}(typ.) = 0.2 V @ I_A$
- Field Stop IGBT Technology
- 10 μ s Short Circuit Capability
- Square RBSOA
- Positive $V_{CE(on)}$ Temperature Coefficient

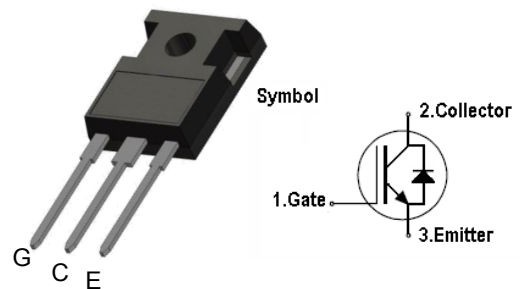

Mechanical Data

- **Case:** TO-247 (plastic package).
Lead free; RoHS compliant
- **Molding Compound Flammability Rating:**
UL 94 V-0
- **Terminals:** High temperature soldering guaranteed:
260 °C/10 sec. at terminals

Benefits

- High Efficiency for Motor Control
- Rugged Performance
- Excellent Current Sharing in Parallel Operation

Applications

CREATEK's IGBTs offer lower losses and higher energy for application such as motor drive ,UPS, inverter and other soft switching applications.

Absolute Maximum Ratings

Symbol	Parameter	Value	Units
V_{CES}	Collector-Emitter Voltage	650	V
V_{GES}	Gate-Emitter Voltage	± 30	V
I_C	Continuous Collector Current ($T_C=25^\circ C$)	10	A
	Continuous Collector Current ($T_C=100^\circ C$)	7	A
I_{CM}	Pulsed Collector Current (Note 1)	100	A
I_F	Diode Continuous Forward Current ($T_C=100^\circ C$)	10	A
I_{FM}	Diode Maximum Forward Current (Note 1)	100	A
t_{sc}	Short Circuit Withstand Time	10	us
I_{SC}	Short Circuit Current	100	A
P_D	Maximum Power Dissipation ($T_C=25^\circ C$)	1.5	W
P_D	Maximum Power Dissipation ($T_C=100^\circ C$)	0.5	W
T_J	Operating Junction Temperature Range	-55 to +150	
T_{STG}	Storage Temperature Range	-55 to +150	

Thermal Characteristics

Symbol	Parameter	Max.	Units
R_{thj-c}	Thermal Resistance, Junction to case for IGBT	0.6	$^\circ C/W$
R_{thj-c}	Thermal Resistance, Junction to case for Diode	0.55	$^\circ C/W$
R_{thj-a}	Thermal Resistance, Junction to Ambient	80	$^\circ C/W$

Electrical Characteristics (TC=25°C unless otherwise noted)

Symbol	Parameter	Test Conditions	Min.	Typ.	Max.	Units
BV_{CES}	Collector-Emitter Breakdown Voltage	$V_{GE} = 0V, I_C = 250\mu A$	650		-	V
I_{CES}	Collector-Emitter Leakage Current	$V_{CE} = 650V, V_{GE} = 0V$	-	-	250	μA
I_{GES}	Gate Leakage Current, Forward	$V_{GE} = 30V, V_{CE} = 0V$	-	-	100	nA
	Gate Leakage Current, Reverse	$V_{GE} = -30V, V_{CE} = 0V$	-	-	-100	nA
$V_{GE(th)}$	Gate Threshold Voltage	$V_{GE} = V_{CE}, I_C = 250\mu A$	4.0		5.5	V
$V_{CE(sat)}$	Collector-Emitter Saturation Voltage	$V_{GE} = 15V, I_C = 75A$	-	1.7		V
Q_g	Total Gate Charge	$V_{CC} = 480V$ $V_{GE} = 15V$ $I_C = 75A$	-	340		nC
Q_{ge}	Gate-Emitter Charge		-	50		nC
Q_{gc}	Gate-Collector Charge		-	180		nC
$t_{d(on)}$	Turn-on Delay Time	$V_{CC} = 400V$ $V_{GE} = 15V$ $I_C = 75A$ $R_G = 10\Omega$ Inductive Load $T_C = 25^\circ C$	-	38	-	ns
t_r	Turn-on Rise Time		-	118	-	ns
$t_{d(off)}$	Turn-off Delay Time		-	267	-	ns
t_f	Turn-off Fall Time		-	81	-	ns
E_{on}	Turn-on Switching Loss		-	4.65	-	mJ
E_{off}	Turn-off Switching Loss		-	2.45	-	mJ
C_{ies}	Input Capacitance	$V_{CE} = 25V$ $V_{GE} = 0V$ $f = 1MHz$	-	2850	-	pF
C_{oes}	Output Capacitance		-	410	-	pF
C_{res}	Reverse Transfer Capacitance		-	185	-	pF
R_{Gint}	Integrated gate resistor	$f = 1M; V_{pp} = 1V$		1.10		Ω

Electrical Characteristics of Diode (TC=25°C unless otherwise noted)

Symbol	Parameter	Test Conditions	Min.	Typ.	Max.	Units
V_F	Diode Forward Voltage	$I_F = 75A$	-	1.5		V
t_{rr}	Diode Reverse Recovery Time	$V_{CE} = 400V$ $I_F = 75A$ $dI_F/dt = 500A/\mu s$	-	80		ns
I_{rrm}	Diode peak Reverse Recovery Current		-	12.5		A
Q_{rr}	Diode Reverse Recovery Charge		-	580		nC

Notes:

1. Repetitive Rating: Pulse width limited by maximum junction temperature

Typical Characteristics

Fig 1. DC Collector current as a function of case temperature ($V_{GE} \geq 15V$, $T_j \leq 150^\circ C$)

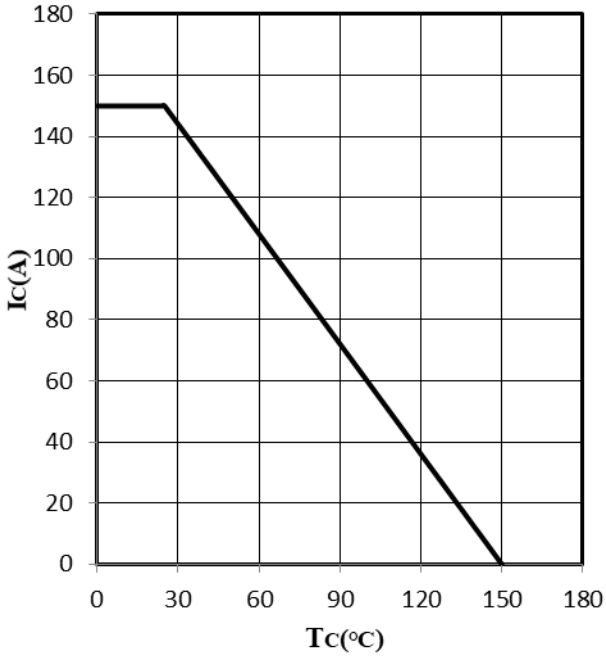

Fig 2. Power dissipation as a function of case temperature ($T_j \leq 150^\circ C$)

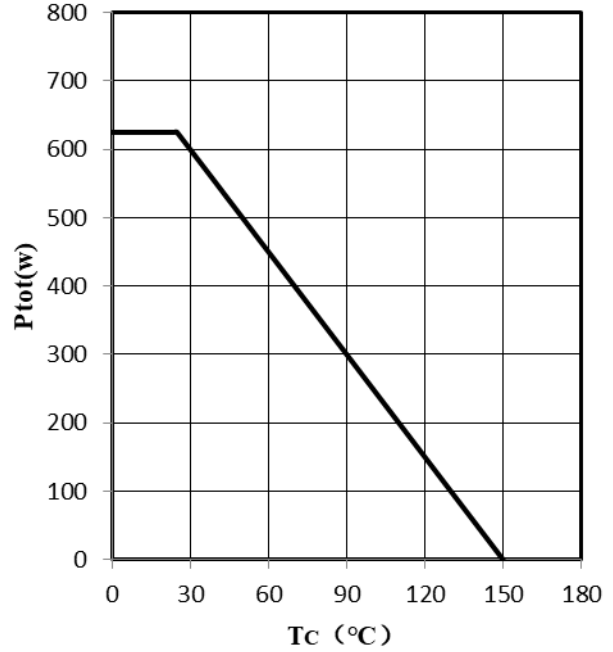

Fig 3. IGBT Forward safe operation area

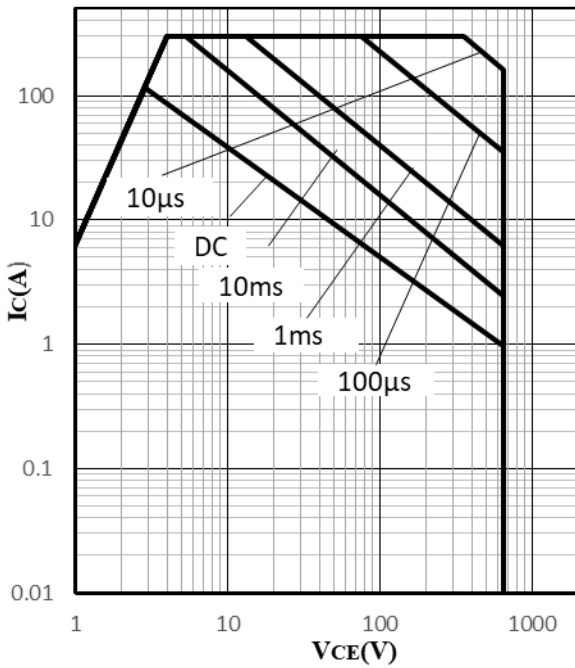
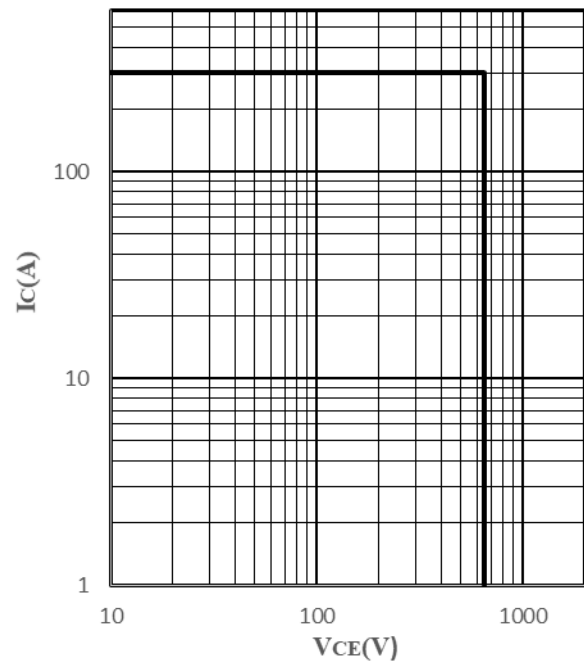

Fig 4. IGBT Reverse safe operation area



Typical Characteristics

Fig 5. Typical output characteristic ($T_j=25^\circ\text{C}$)

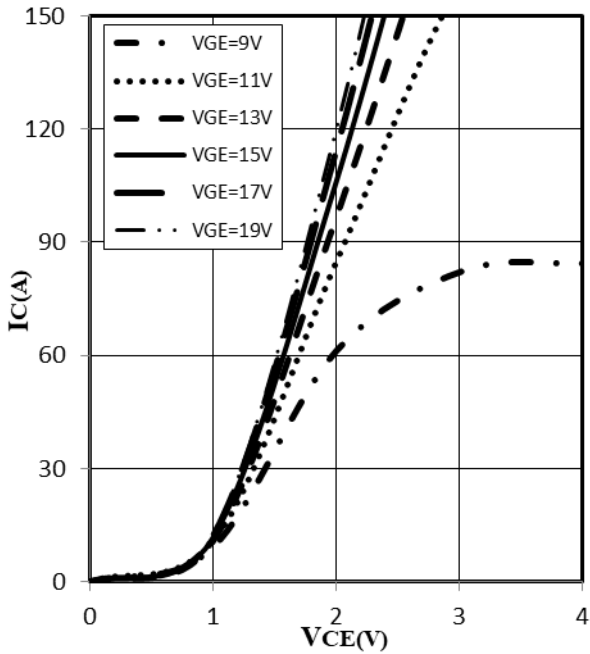

Fig 6. Typical output characteristic ($T_j=125^\circ\text{C}$)

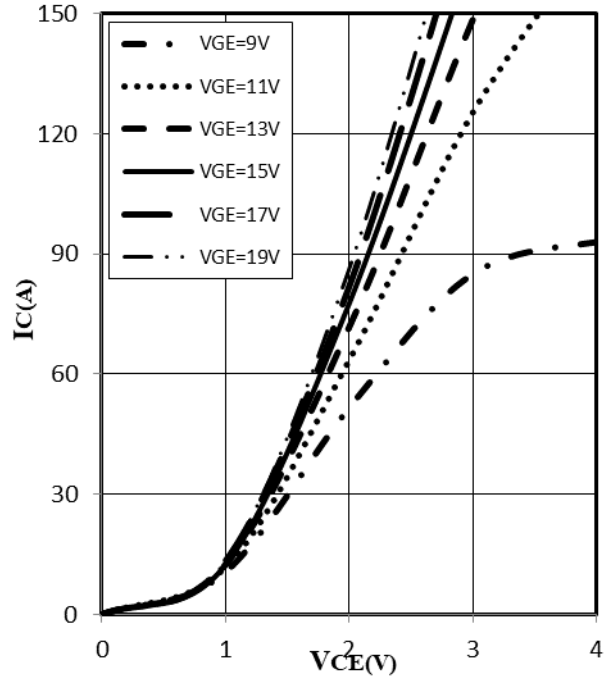

Fig 7. Typical transfer characteristic ($V_{CE}=20\text{V}$)

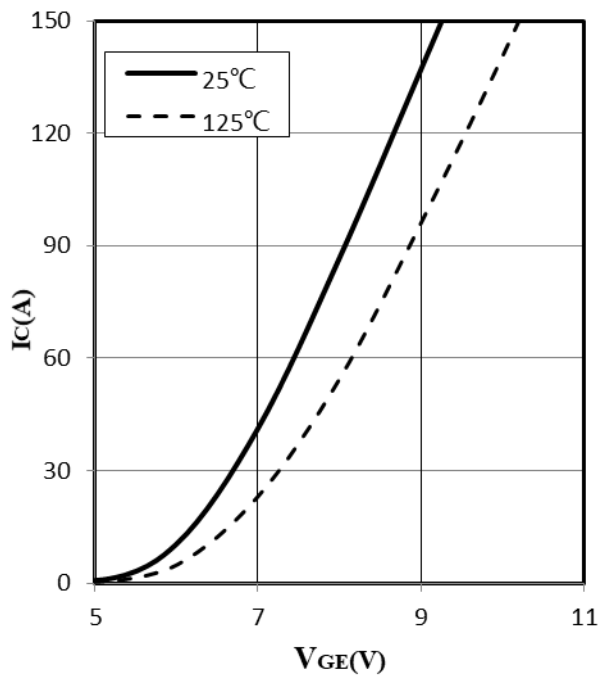
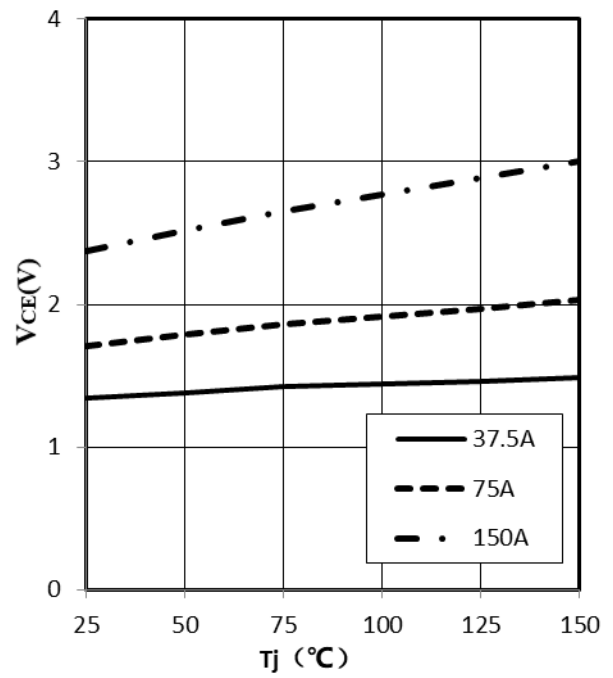

Fig 8. Typical collector-emitter saturation voltage as a function of junction temperature ($V_{GE}=15\text{V}$)



Typical Characteristics

Fig 9. Typical collector-emitter saturation voltage as a function of V_{GE} ($T_j=25^\circ\text{C}$)

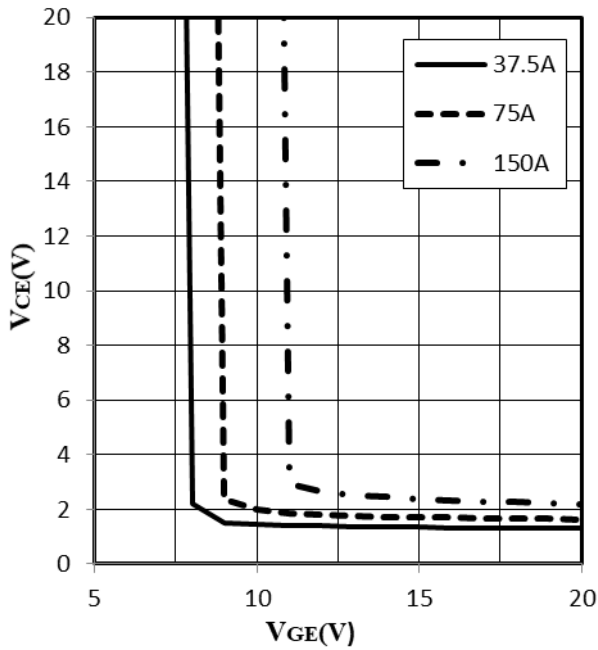

Fig 10. Typical collector-emitter saturation voltage as a function of V_{GE} ($T_j=125^\circ\text{C}$)

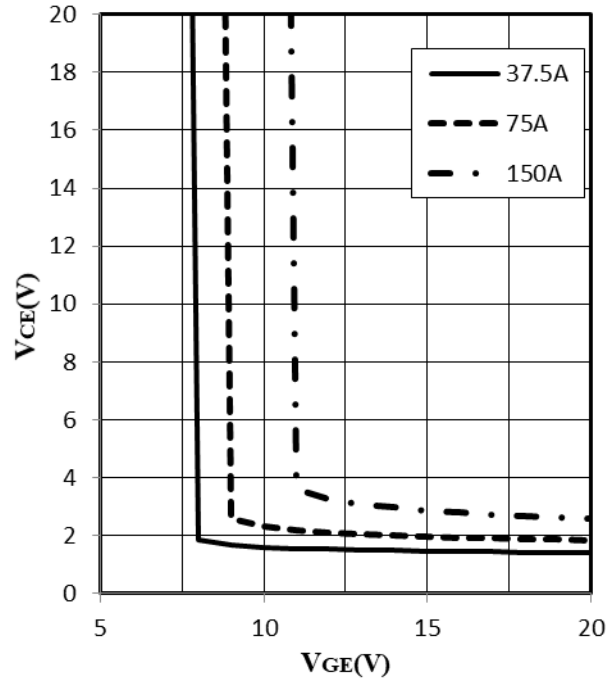

Fig 11. Typical switch energy as a function of I_c (inductive load, $T_j=25^\circ\text{C}$, $V_{CE}=400\text{V}$, $V_{GE}=15\text{V}$, $R_G=10\Omega$)

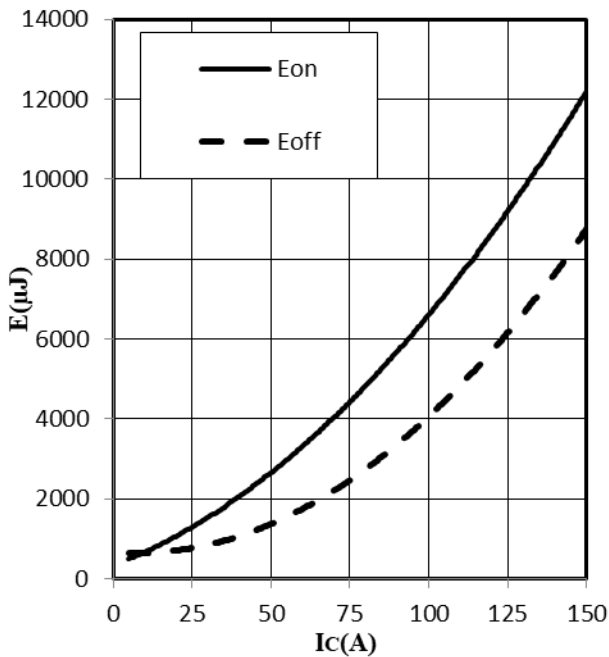
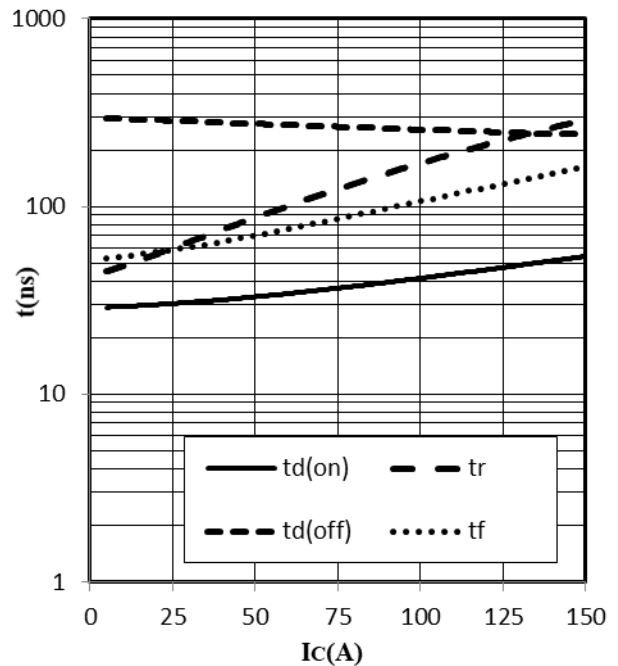

Fig 12. Typical switch time as a function of I_c (inductive load, $T_j=25^\circ\text{C}$, $V_{CE}=400\text{V}$, $V_{GE}=15\text{V}$, $R_G=10\Omega$)



Typical Characteristics

Fig 13. Typical switch energy as a function of R_G (inductive load, $T_j=25^\circ\text{C}$, $V_{CE}=400\text{V}$, $V_{GE}=15\text{V}$, $I_c=75\text{A}$)

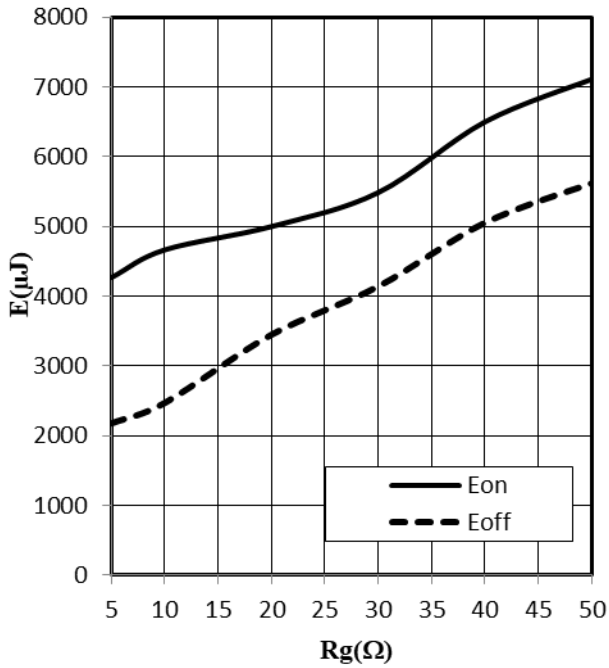

Fig 14. Typical switch time as a function of R_G (inductive load, $T_j=25^\circ\text{C}$, $V_{CE}=400\text{V}$, $V_{GE}=15\text{V}$, $I_c=75\text{A}$)

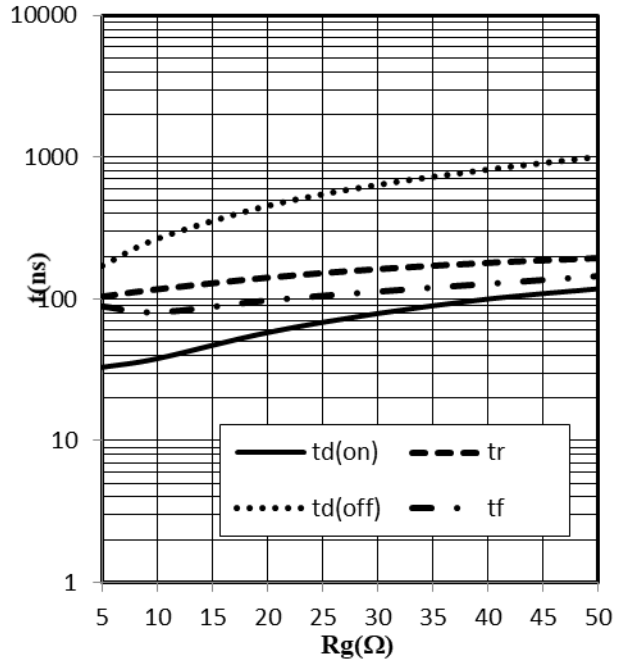

Fig 15. Typical capacitance as a function of collector-emitter voltage ($V_{GE}=0\text{V}$, $f=1\text{MHz}$)

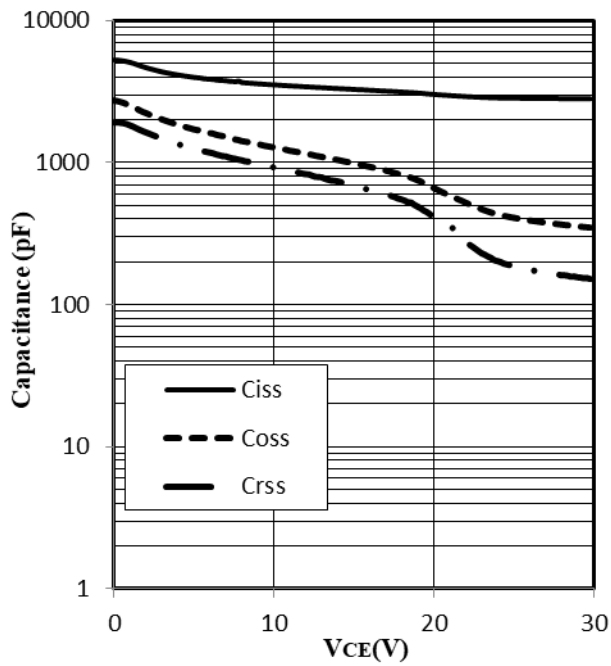
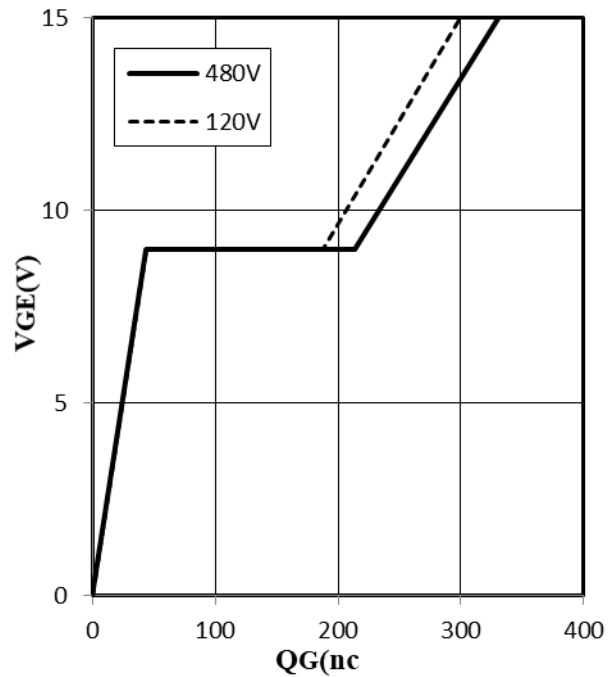

Fig 16. Typical gate charge ($I_c=75\text{A}$)



Typical Characteristics

Fig 17. Typical diode forward current as a function of forward voltage

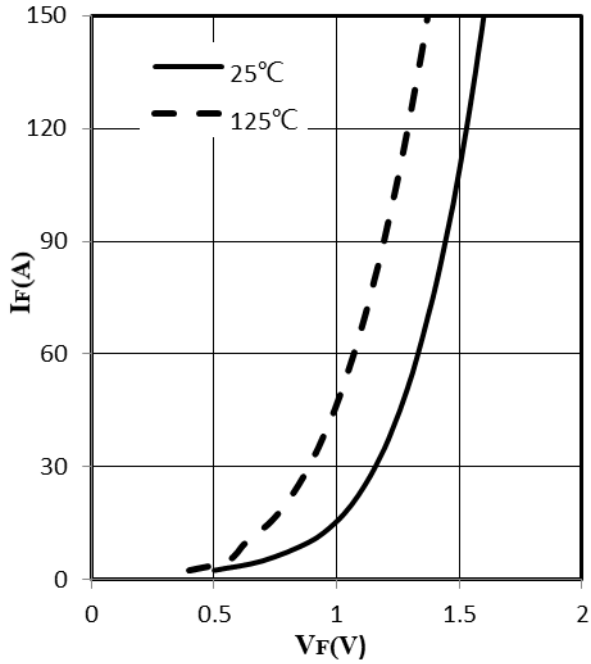

Fig 18. Typical trr as a function of dI_F/dt

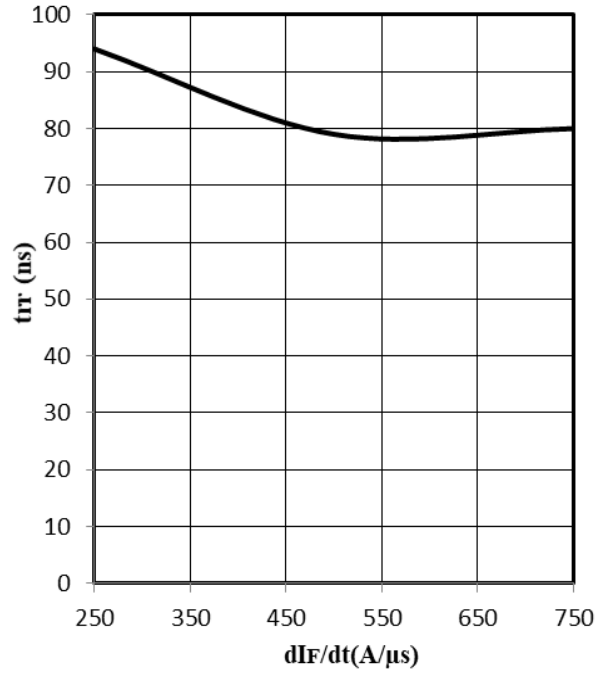

Fig 19. Typical I_{rrm} as a function of dI_F/dt

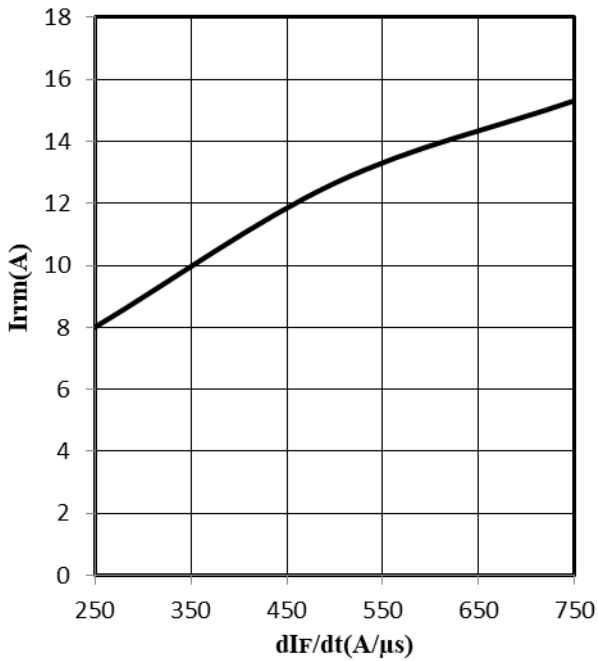
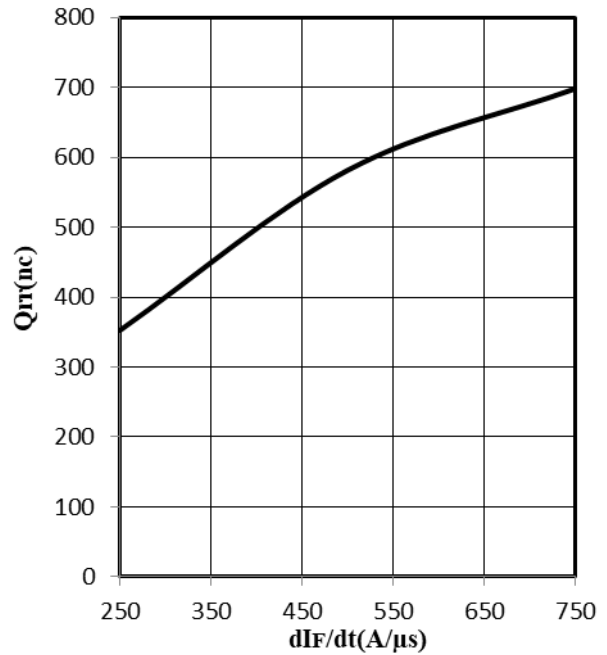
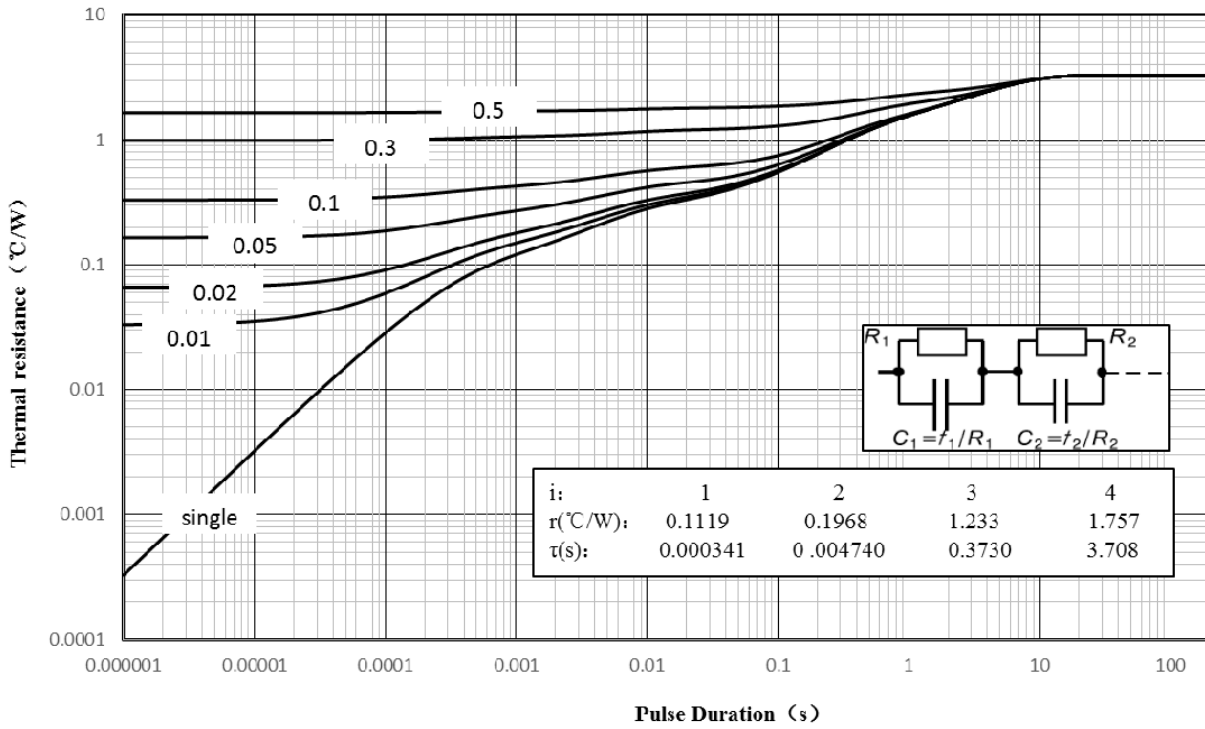

Fig 20. Typical Q_{rr} as a function of dI_F/dt



Typical Characteristics

Fig 21. IGBT transient thermal resistance($D=tp/T$)



Package Dimensions

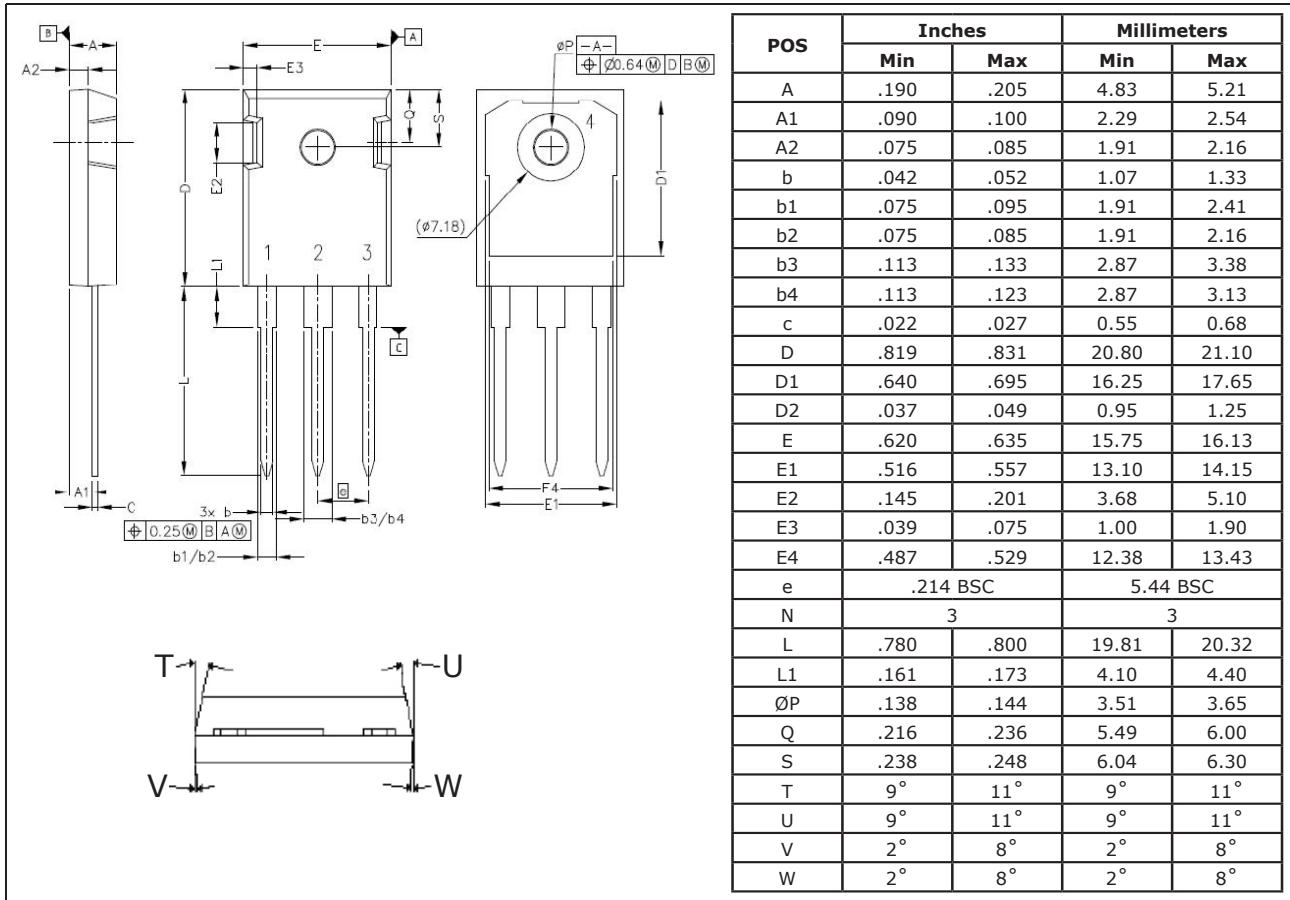

Ordering information

Order code	Package	Packaging option	Base quantity	Packaging specification
CXG75N65HS	TO-247	Tube/BOX	2000pcs / BOX	

Revision history

Date	Revision	Changes
23-May-2017	1.0	Initial release

CAUTION / WARNING

Information in this document is believed to be accurate and reliable. However, CREATEK does not give any representations or warranties, expressed or implied, as to the accuracy or completeness of such information and shall have no liability for the consequences of use of such information.

Users should independently evaluate the suitability of and test each product selected for their own applications, and CREATEK assumes no liability whatsoever relating to the choice, selection or use of the CREATEK products and services described herein.

CREATEK reserves the right to change or update, without notice, any information contained in this publication; to change, without notice, the design, construction, processing, or specification of any product; and to discontinue or limit production or distribution of any product.

Information in this document supersedes and replaces all information previously supplied.

Products are not designed, authorized or warranted to be suitable for use in medical, military, aircraft, space or life support equipment, nor in applications where failure or malfunction of an CREATEK product can reasonably be expected to result in personal injury, death or severe property or environmental damage. CREATEK accepts no liability for inclusion and/or use of CREATEK products in such equipment or applications and therefore such inclusion and/or use is at the customer's own risk.

This document as well as the item(s) described herein may be subject to export control regulations. Export might require a prior authorization from national authorities.

Resale of CREATEK products with provisions different from the statements and/or technical features set forth in this document shall immediately void any warranty granted by CREATEK for the CREATEK product or service described herein and shall not create or extend in any manner whatsoever, any liability of CREATEK.

CREATEK expressly disclaims all implied warranties regarding the information contained herein, including, but not limited to, any implied warranties of merchantability or fitness for a particular purpose. CREATEK only obligations are those in the CREATEK Standard Terms and Conditions of Sale and in no case will CREATEK be liable for any incidental, indirect, or consequential damages arising from the sale, resale, use, or misuse of its products.

Specifications are subject to change without notice

© Copyright 2009, CREATEK Microelectronics

 CREATEK® is a registered trademark of CREATEK Microelectronics

All rights reserved