

**SMBG Plastic-Encapsulate Diodes****1SMB59 SERIES** Zener Voltage Suppressor Diodes**Features**

- $P_d$  3.0W
- $V_z$  3.3V-200V
- Glass passivated chip
- The marking bar indicates the cathode

**Applications**

- Stable Voltage

**Marking**

- 1SMB59XXB  
XX : From 13 To 56

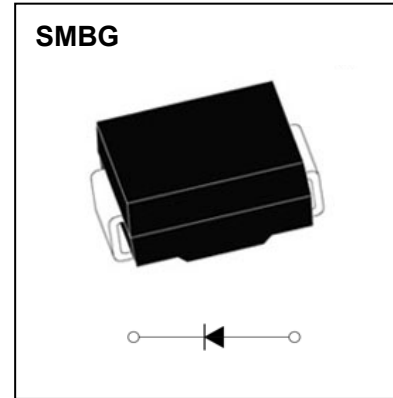
**Limiting Values(Absolute Maximum Rating)**

Item	Symbol	Unit	Conditions	Max
Power dissipation	$P_d$	W	$T_L=75^{\circ}\text{C}$	3
Zener current	$I_z$	mA		$P_V/V_z$
Operation Junction and Storage Temperature Range	$T_J, T_{stg}$	$^{\circ}\text{C}$		-55 ~ +150

**Electrical Characteristics ( $T_a=25^{\circ}\text{C}$  Unless otherwise specified)**

Item	Symbol	Unit	Conditions	Max
Thermal resistance	$R_{\theta JA}$	$^{\circ}\text{C}/\text{W}$	Between junction to ambient	75
	$R_{\theta JL}$	$^{\circ}\text{C}/\text{W}$	Between junction to lead	30
Forward voltage	$V_F$	V	$I_F=200\text{mA}$	1.5

## Electrical Characteristics ( $T_A=25^{\circ}\text{C}$ unless otherwise noted)

Device (Note 2)	Zener Voltage (Note 3)			Zener Impedance (Note 4)			Leakage Current		$I_{ZM}$	
	$V_Z$ (Volts)			$@ I_{ZT}$	$Z_{ZT} @ I_{ZT}$	$Z_{ZK} @ I_{ZK}$		$I_R @ V_R$		
	Min	Nom	Max	mA	$\Omega$	$\Omega$	mA	$\mu\text{A}$	Volts	mA(dc)
1SMB5913B	3.13	3.3	3.47	113.6	10	500	1	100	1	454
1SMB5914B	3.42	3.6	3.78	104.2	9	500	1	75	1	416
1SMB5915B	3.70	3.9	4.10	96.1	7.5	500	1	25	1	384
1SMB5916B	4.08	4.3	4.52	87.2	6	500	1	5	1	348
1SMB5917B	4.46	4.7	4.94	79.8	5	500	1	5	1.5	319
1SMB5918B	4.84	5.1	5.36	73.5	4	350	1	5	2	294
1SMB5919B	5.32	5.6	5.88	66.9	2	250	1	5	3	267
1SMB5920B	5.89	6.2	6.51	60.5	2	200	1	5	4	241
1SMB5921B	6.46	6.8	7.14	55.1	2.5	200	1	5	5.2	220
1SMB5922B	7.12	7.5	7.88	50	3	400	0.5	5	6	200
1SMB5923B	7.79	8.2	8.61	45.7	3.5	400	0.5	5	6.5	182
1SMB5924B	8.64	9.1	9.56	41.2	4	500	0.5	5	7	164
1SMB5925B	9.5	10	10.5	37.5	4.5	500	0.25	5	8	150
1SMB5926B	10.45	11	11.55	34.1	5.5	550	0.25	1	8.4	136
1SMB5927B	11.4	12	12.6	31.2	6.5	550	0.25	1	9.1	125
1SMB5928B	12.35	13	13.65	28.8	7	550	0.25	1	9.9	115
1SMB5929B	14.25	15	15.75	25	9	600	0.25	1	11.4	100
1SMB5930B	15.2	16	16.8	23.4	10	600	0.25	1	12.2	93
1SMB5931B	17.1	18	18.9	20.8	12	650	0.25	1	13.7	83
1SMB5932B	19	20	21	18.7	14	650	0.25	1	15.2	75
1SMB5933B	20.9	22	23.1	17	17.5	650	0.25	1	16.7	68
1SMB5934B	22.8	24	25.2	15.6	19	700	0.25	1	18.2	62
1SMB5935B	25.65	27	28.35	13.9	23	700	0.25	1	20.6	55
1SMB5936B	28.5	30	31.5	12.5	28	750	0.25	1	22.8	50
1SMB5937B	31.35	33	34.65	11.4	33	800	0.25	1	25.1	45
1SMB5938B	34.2	36	37.8	10.4	38	850	0.25	1	27.4	41
1SMB5939B	37.05	39	40.95	9.6	45	900	0.25	1	29.7	38
1SMB5940B	40.85	43	45.15	8.7	53	950	0.25	1	32.7	34
1SMB5941B	44.65	47	49.35	8	67	1000	0.25	1	35.8	31
1SMB5942B	48.45	51	53.55	7.3	70	1100	0.25	1	38.8	29
1SMB5943B	53.2	56	58.8	6.7	86	1300	0.25	1	42.6	26
1SMB5944B	58.9	62	65.1	6	100	1500	0.25	1	47.1	24
1SMB5945B	64.6	68	71.4	5.5	120	1700	0.25	1	51.7	22
1SMB5946B	71.25	75	78.75	5	140	2000	0.25	1	56	20
1SMB5947B	77.9	82	86.1	4.6	160	2500	0.25	1	62.2	18
1SMB5948B	86.45	91	95.55	4.1	200	3000	0.25	1	69.2	16
1SMB5949B	95	100	105	3.7	250	3100	0.25	1	76	15
1SMB5950B	104.5	110	115.5	3.4	300	4000	0.25	1	83.6	13
1SMB5951B	114	120	126	3.1	380	4500	0.25	1	91.2	12
1SMB5952B	123.5	130	136.5	2.9	450	5000	0.25	1	98.8	11
1SMB5953B	142.5	150	157.5	2.5	600	6000	0.25	1	114	10
1SMB5954B	152	160	168	2.3	700	6500	0.25	1	121.6	9
1SMB5955B	171	180	189	2.1	900	7000	0.25	1	136.8	8
1SMB5956B	190	200	210	1.9	1200	8000	0.25	1	152	7

### Notes :

- (1) The type number listed have a standard tolerance on the nominal zener voltage of  $\pm 5\%$
- (2) The reverse surge current is a non-repetitive, 8.3ms pulse width square wave or equivalent sine-wave superimposed on  $I_{ZT}$  per method

# Typical Characteristics

Figure 1. Steady State Power Derating

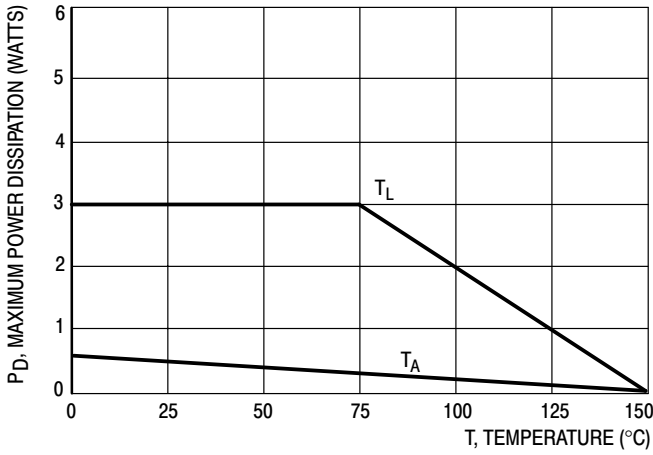

Figure 2. Maximum Surge Power

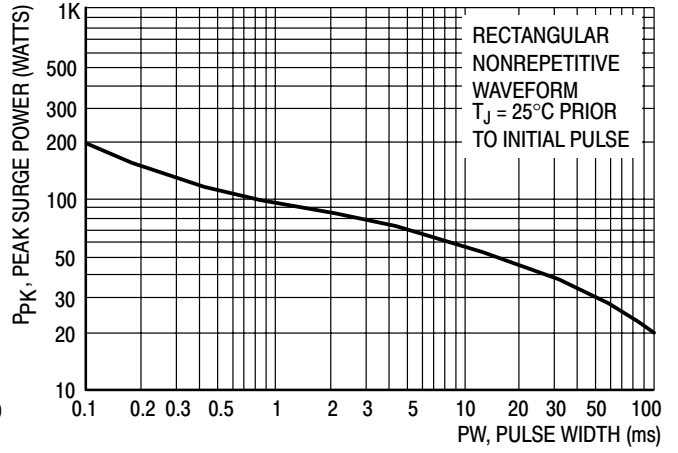

Figure 3. Zener Voltage – To 12 Volts

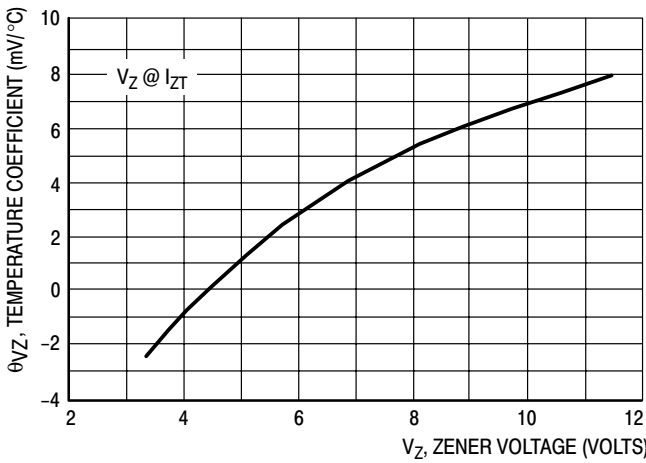

Figure 4. Zener Voltage – 14 To 200 Volts

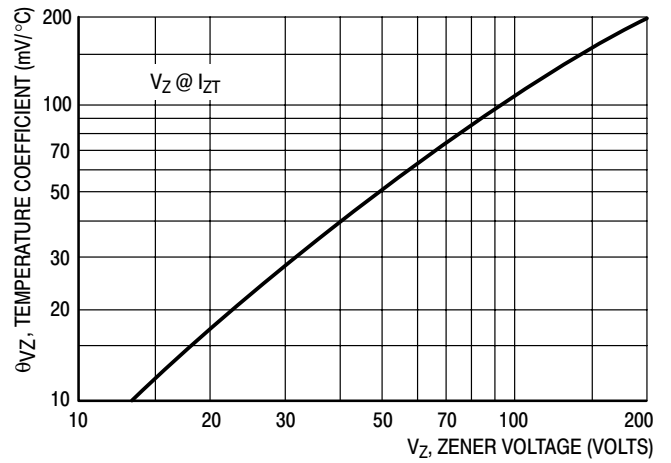

Figure 5. V<sub>Z</sub> = 3.3 thru 10 Volts

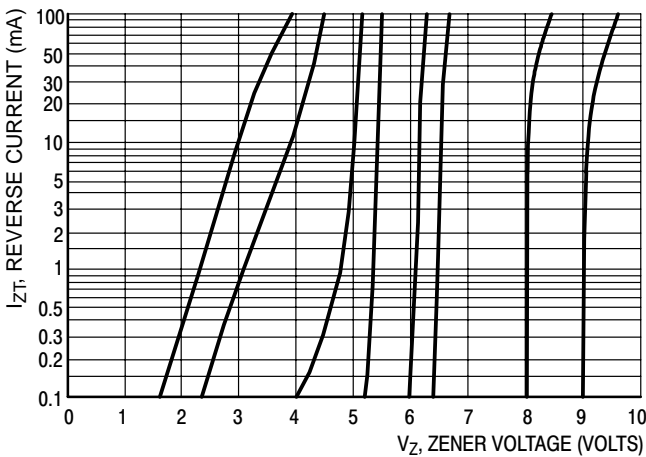
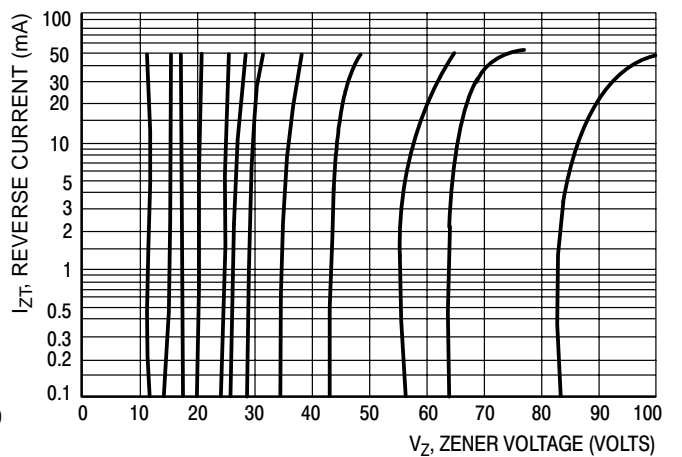
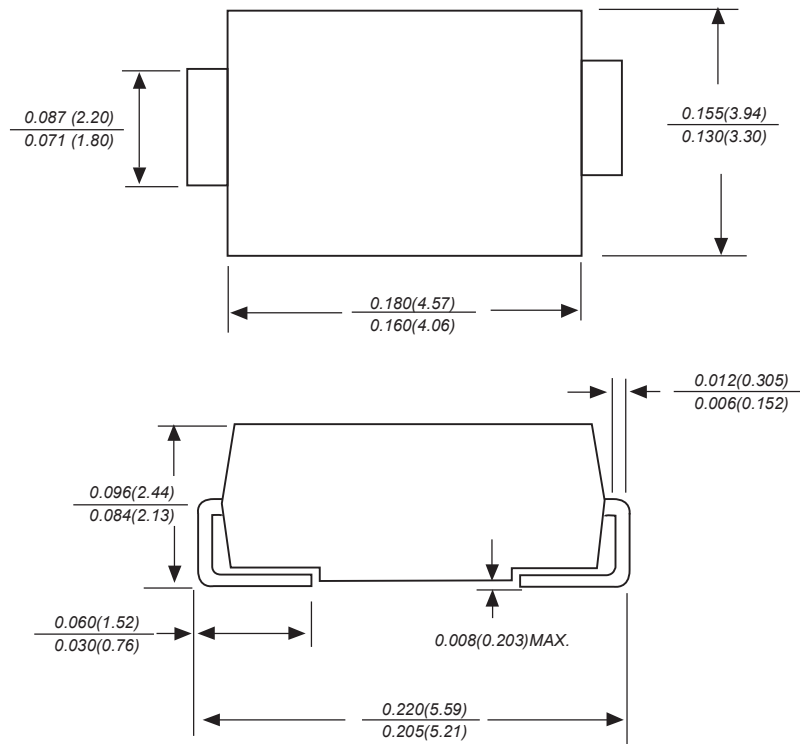

Figure 6. V<sub>Z</sub> = 12 thru 82 Volts



## SMBG Package Outline Dimensions



Dimensions in inches and (millimeters)

## SMBG Suggested Pad Layout

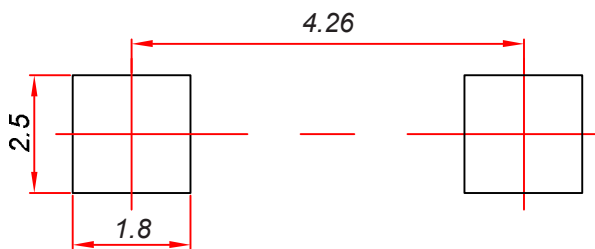

### Note:

1. Controlling dimension: in millimeters.
2. General tolerance:  $\pm 0.05 \text{ mm}$ .
3. The pad layout is for reference purposes only.

### NOTICE

JSCJ reserves the right to make modifications, enhancements, improvements, corrections or other changes without further notice to any product herein. JSCJ does not assume any liability arising out of the application or use of any product described herein.

# Reel Taping Specifications For Surface Mount Devices-SMBG

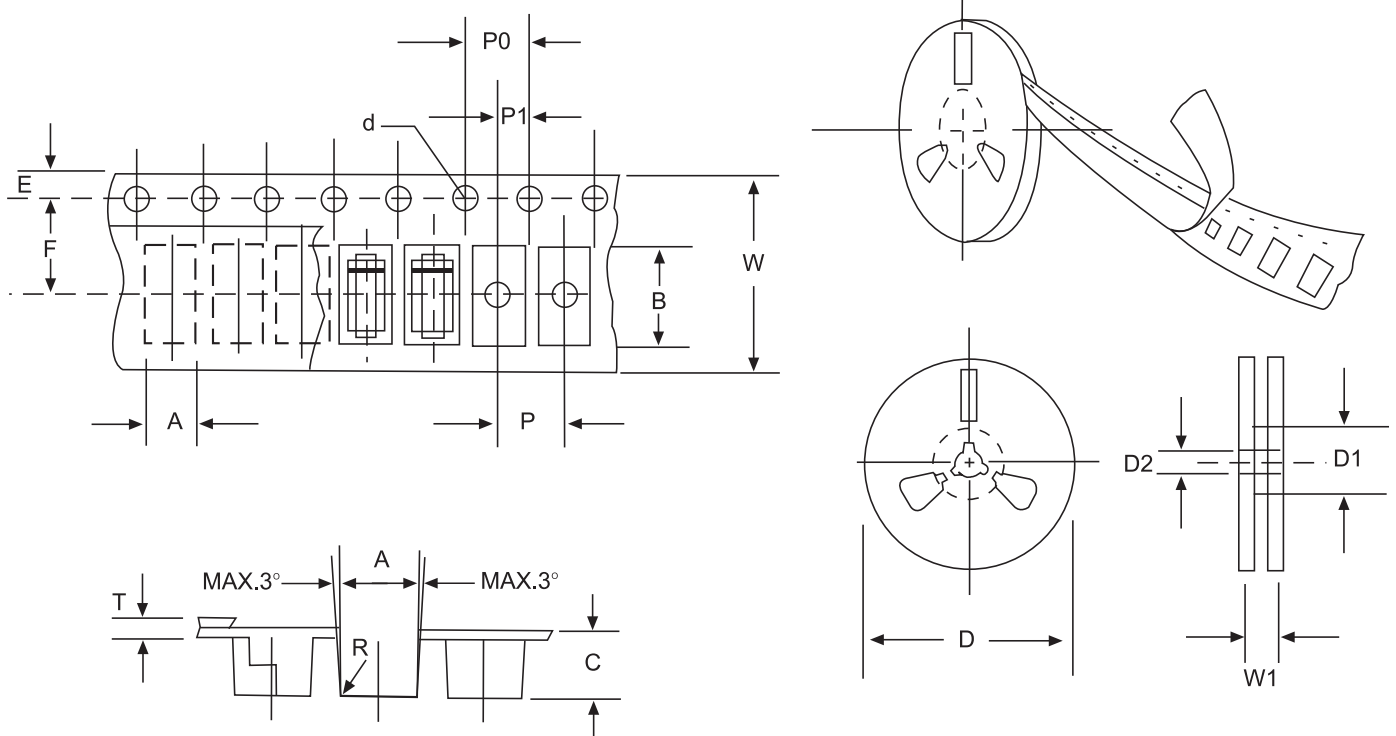

**FIG: CONFIGURATION OF SURFACE MOUNTED DEVICES TAPING**

ITEM	SYMBOL	SMBG mm(inch)
Carrier width	A	4.09±0.1(0.161±0.004)
Carrier length	B	5.82±0.1(0.229±0.004)
Carrier depth	C	2.50±0.1(0.100±0.004)
Sprocket hole	d	1.55±0.05(0.061±0.002)
Reel outside diameter	D	330±2.0(13±0.079)
Reel inner diameter	D1	75±1.0 ( 2.95 ±0.039)
Feed hole diameter	D2	13±0.5(0.512±0.020)
Strocket hole position	E	1.75±0.1(0.069±0.004)
Punch hole position	F	5.65±0.05(0.222±0.002)
Punch hole pitch	P	8.0±0.1(0.315±0.004)
Sprocket hole pitch	P0	4.0±0.1(0.157±0.004)
Embossment center	P1	2.0±0.1(0.079±0.004)
Total tape thickness	T	0.32±0.1(0.013±0.004)
Tape width	W	12.0±0.2(0.472±0.008)
Reel width	W1	16.8±2.0(0.661±0.079)

NOTE: Devices are packed in accordance with EIA standard RS-481-A and specification given above.