

CRYSTAL OSCILLATOR (Programmable)
OUTPUT: CMOS



Product Number
X1G005171xxxx00

SG-8101CGA

- Frequency range : 0.67 MHz to 170 MHz (1 ppm Step)
- Supply voltage : 1.62 V to 3.63 V
- Function : Output enable (OE) or Standby (ST)
- Frequency tolerance, operating temperature:
 - ±15 ppm (-40 °C to +85 °C)
 - ±20 ppm (-40 °C to +105 °C)
 - ±50 ppm (-40 °C to +125 °C)
 - ±100 ppm (-40 °C to +125 °C)
- Package : 2.5 x 2.0 (mm)
- PLL technology to enable short lead time
- Conform to AEC-Q100



Specifications (characteristics)

Item	Symbol	Specifications				Conditions/Remarks					
Supply voltage	V _{cc}	1.80 V Typ.		2.50 V Typ.	3.30 V Typ.						
		1.62 V to 1.98 V	1.98 V to 2.20 V	2.20 V to 2.80 V	2.70 V to 3.63 V						
Output frequency range	f _o	0.67 MHz to 170 MHz									
Storage temperature	T _{stg}	-40 °C to +125 °C				Storage as single product.					
Operating temperature	T _{use}	-40 °C to +85 °C									
		-40 °C to +105 °C									
Frequency tolerance*1	f _{tol}	B : ±15 × 10 ⁻⁶				T _{use} = -40 °C to +85 °C					
		C : ±20 × 10 ⁻⁶				T _{use} = -40 °C to +105 °C					
		J : ±50 × 10 ⁻⁶				T _{use} = -40 °C to +125 °C					
		L : ±100 × 10 ⁻⁶				T _{use} = -40 °C to +125 °C					
Current consumption	I _{cc}	3.3 mA Max.	3.4 mA Max.	3.5 mA Max.	3.6 mA Max.	T _{use} = +125 °C	No load, f _o = 20 MHz				
		3.2 mA Max.	3.3 mA Max.	3.4 mA Max.	3.5 mA Max.	T _{use} = +105 °C					
		2.7 mA Typ.		2.9 mA Typ.	3.0 mA Typ.	T _{use} = +25 °C					
		5.6 mA Max.	5.9 mA Max.	6.8 mA Max.	8.2 mA Max.	T _{use} = +125 °C					
		5.5 mA Max.	5.8 mA Max.	6.7 mA Max.	8.1 mA Max.	T _{use} = +105 °C					
Output disable current	I _{dis}	4.7 mA Typ.		5.7 mA Typ.	6.8 mA Typ.	T _{use} = +25 °C	No load, f _o = 170 MHz				
		3.3 mA Max.	3.4 mA Max.	3.4 mA Max.	3.6 mA Max.	T _{use} = +125 °C					
		3.2 mA Max.	3.3 mA Max.	3.3 mA Max.	3.5 mA Max.	T _{use} = +105 °C					
Standby current	I _{std}	2.3 µA Max.	2.5 µA Max.	3.0 µA Max.	4.2 µA Max.	T _{use} = +125 °C	ST = GND				
		0.9 µA Max.	1.0 µA Max.	1.5 µA Max.	2.5 µA Max.	T _{use} = +105 °C					
		0.3 µA Typ.	0.4 µA Typ.	0.5 µA Typ.	1.1 µA Typ.	T _{use} = +25 °C					
Symmetry	SYM	45 % to 55 %				50 % V _{cc} Level					
Output voltage (DC characteristics)	V _{OH}	90 % V _{cc} Min.				I _{OH} /I _{OL} Conditions [mA]					
						Rise/Fall time selection	V _{cc}	*A	*B	*C	*D
						Default (f _o > 40 MHz), Fast	I _{OH}	2.5	3.5	4.0	5.0
						Default (f _o ≤ 40 MHz)	I _{OH}	-1.5	-2.0	-2.5	-3.0
						Slow	I _{OL}	1.5	2.0	2.5	3.0
							I _{OL}	-1.0	-1.5	-2.0	-2.5
						*A: 1.62 V to 1.98 V, *B: 1.98 V to 2.20 V, *C: 2.20 V to 2.80 V, *D: 2.70 V to 3.63 V					
Output load condition	L _{CMOS}	15 pF Max.									
Input voltage	V _H	70 % V _{cc} Min.				OE or ST					
	V _L	30 % V _{cc} Max.									
Rise and Fall time	Default	tr/ff	3.0 ns Max.				f _o > 40 MHz				
			6.0 ns Max.				f _o ≤ 40 MHz				
			3.0 ns Max.				f _o = 0.67 MHz to 170 MHz				
			10.0 ns Max.				f _o = 0.67 MHz to 20 MHz				
Disable Time	t _{stp}	1 µs Max.				Measured from the time OE or ST pin crosses 30 % V _{cc}					
Enable Time	t _{sta}	1 µs Max.				Measured from the time OE pin crosses 70 % V _{cc}					
Resume Time	t _{res}	3 ms Max.				Measured from the time ST pin crosses 70 % V _{cc}					
Start-up time	t _{str}	3 ms Max.				Measured from the time V _{cc} reaches its rated minimum value, 1.62 V					
Frequency aging	f _{aging}	This is included in frequency tolerance specification.				+25 °C, first year					

*1 Frequency tolerance includes initial frequency tolerance, temperature variation, supply voltage variation, reflow drift, load drift and aging (+25 °C, 1 year).

Pin description

Pin	Name	I/O type	Function	
1	OE	Input	Output enable	High: Specified frequency output from OUT pin Low: Out pin is low (weak pull down), only output driver is disabled.
	ST	Input	Standby	High: Specified frequency output from OUT pin Low: Out pin is low (weak pull down), Device goes to standby mode. Supply current reduces to the least as I _{std} .
2	GND	Power	Ground	
3	OUT	Output	Clock output	
4	V _{cc}	Power	Power supply	



Product Name

SG-8101CGA 170.000000MHz I C H P A
① ② ③ ④ ⑤ ⑥ ⑦ ⑧

② Package type
CG: 2.5 mm x 2.0 mm
④ Supply voltage
T: 1.8 V to 3.3 V Typ.

⑤⑥ ⑤ Frequency tolerance	⑥ Operating
BG B: 15×10^{-6}	G: -40°C to $+85^{\circ}\text{C}$
CH C: 20×10^{-6}	H: -40°C to $+105^{\circ}\text{C}$
JJ J: 50×10^{-6}	J: -40°C to $+125^{\circ}\text{C}$
LJ L: 100×10^{-6}	

⑦ Function
P: Output Enable
S: Standby

- ① Model, ② Package type,
- ③ Frequency, ④ Supply voltage,
- ⑤ Frequency tolerance, ⑥ Operating temperature,
- ⑦ Function, ⑧ Rise/Fall time

⑧ Rise/Fall time
A: Default
B: Fast
C: Slow

External dimensions

(Unit: mm)

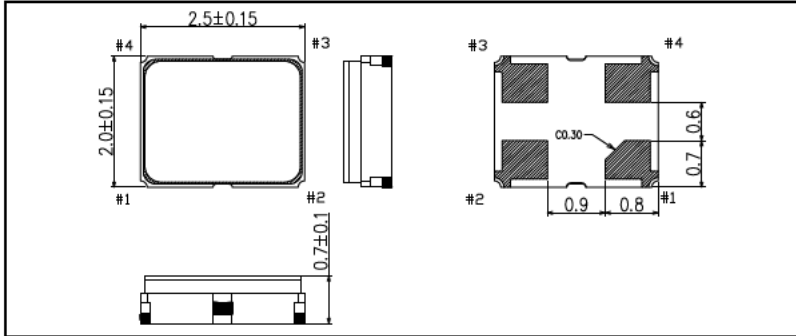

Footprint (Recommended)

(Unit: mm)

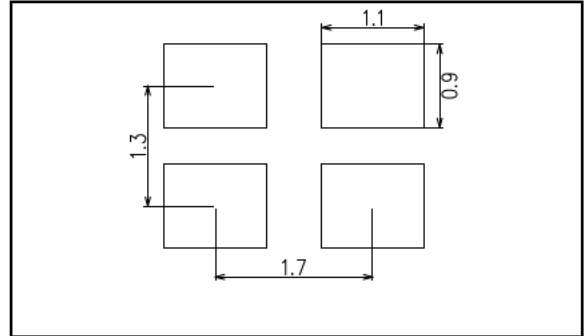

Notes:

In order to achieve optimum jitter performance, the 0.1 μF capacitor between V_{CC} and GND should be placed. It is also recommended that the capacitors are placed on the device side of the PCB, as close to the device as possible and connected together with short wiring pattern.

Specification Graph (Typical supplemental specification. Unless otherwise specified $T_{use} = 25\text{ }^{\circ}\text{C}$, $L_{CMOS} = 15\text{ pF}$)

Current Consumption

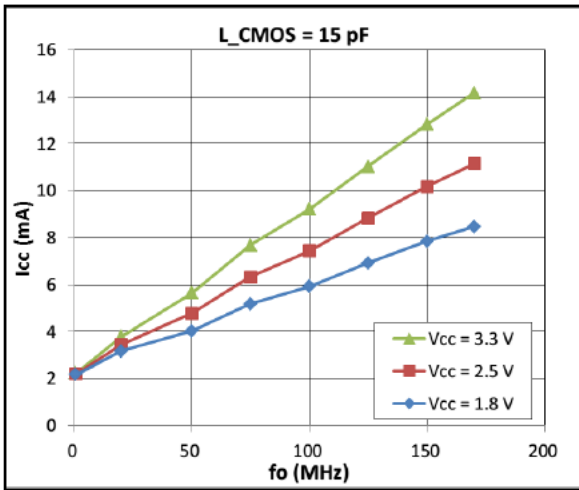
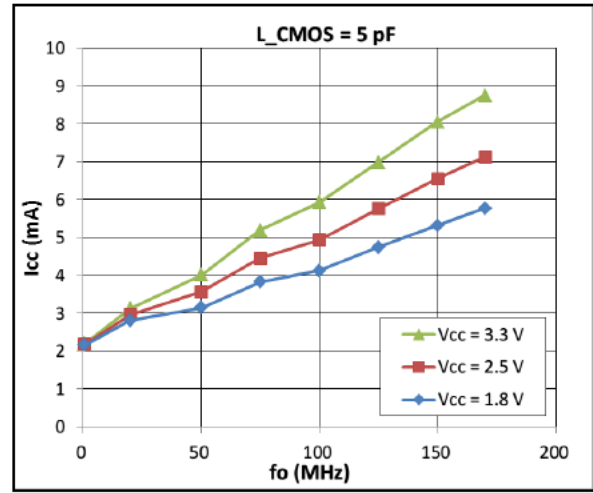
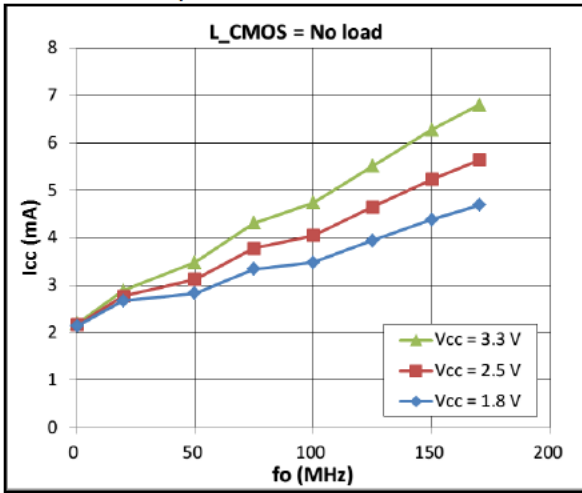

Output disable current

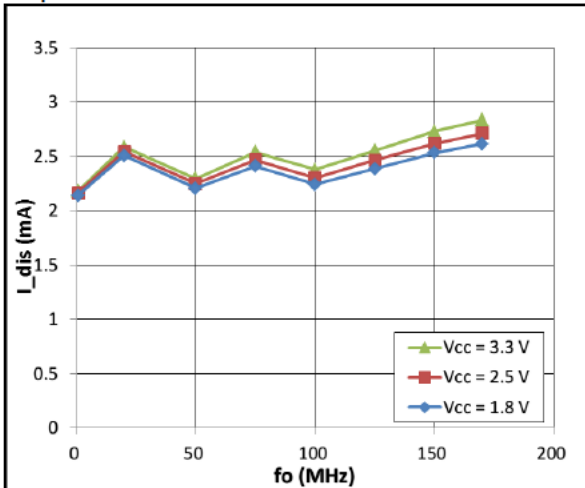

Standby current

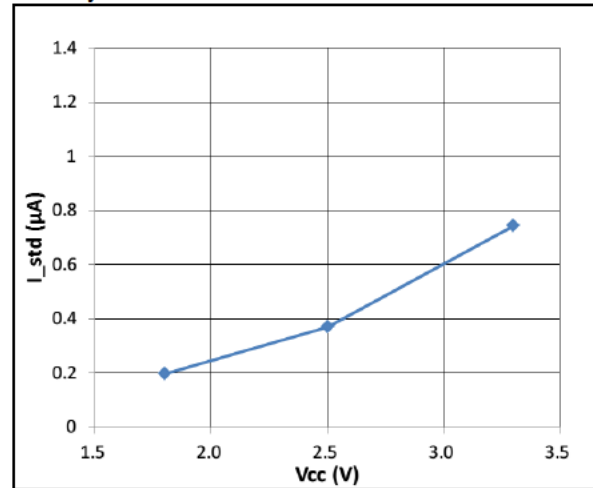

■ Notes:





Specification Graph (Typical supplemental specification. Unless otherwise specified $T_{use} = 25\text{ }^{\circ}\text{C}$, $L_{CMOS} = 15\text{ pF}$)

Phase Jitter RMS

(Integration bandwidth 12 k to 20 MHz)

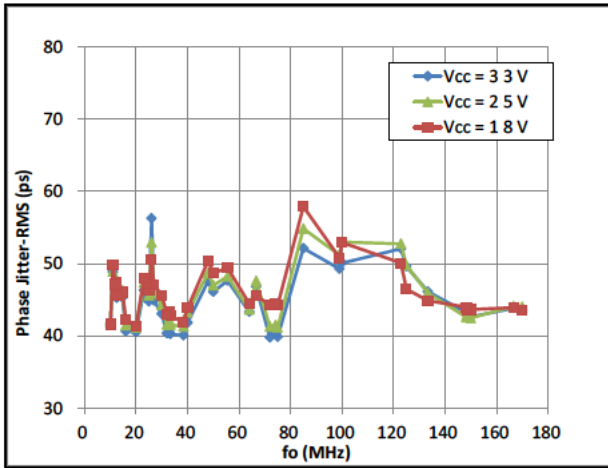

Phase Jitter RMS

(Integration bandwidth 1.8 M to 20 MHz)

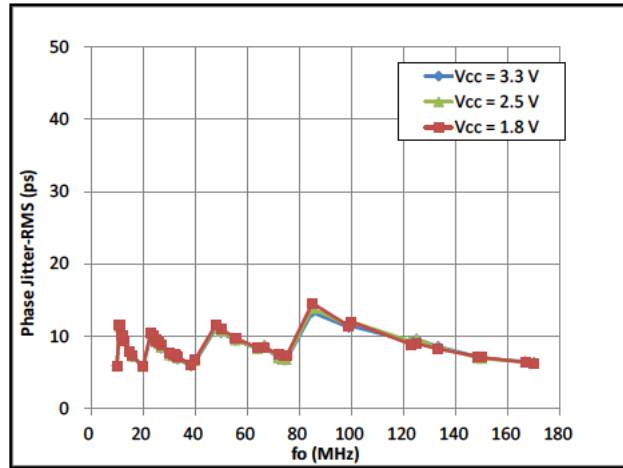

Period Jitter RMS

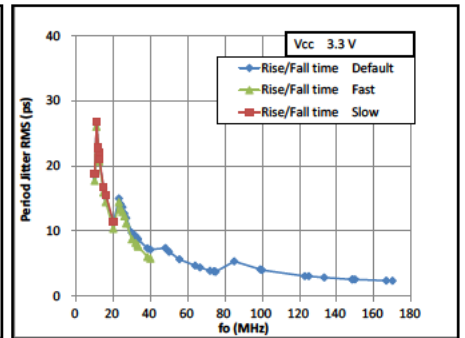
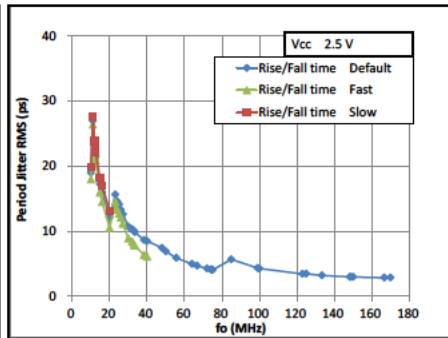
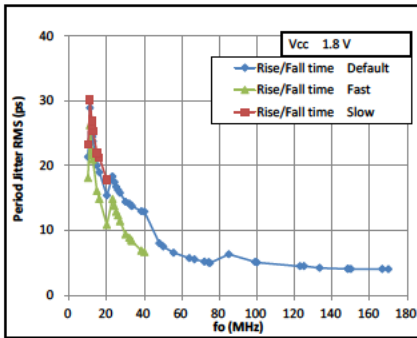

Period Jitter Peak-Peak

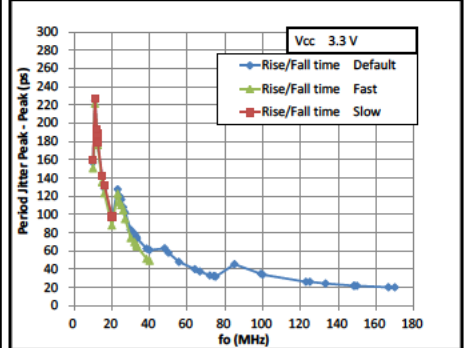
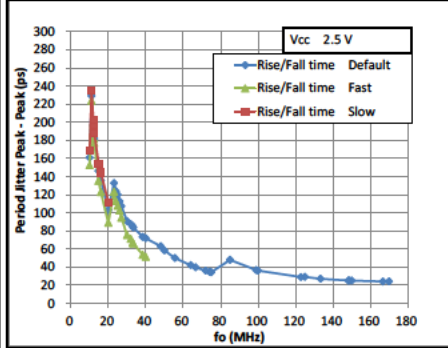
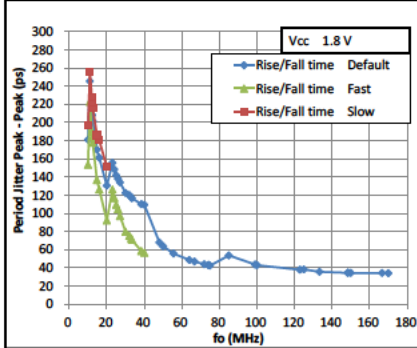

Cycle-to-Cycle Jitter Peak-Peak

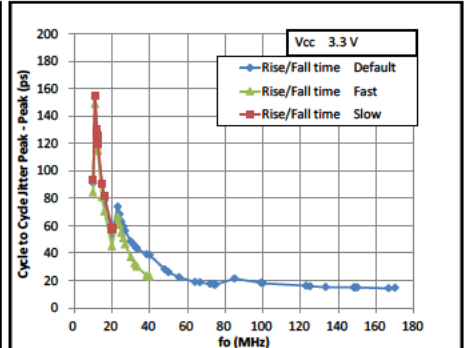
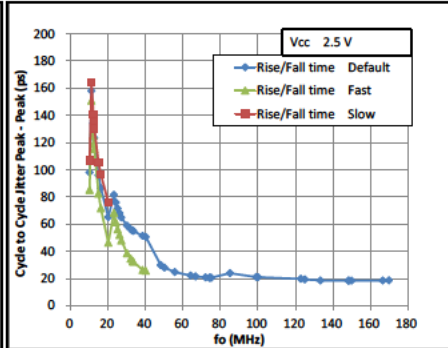
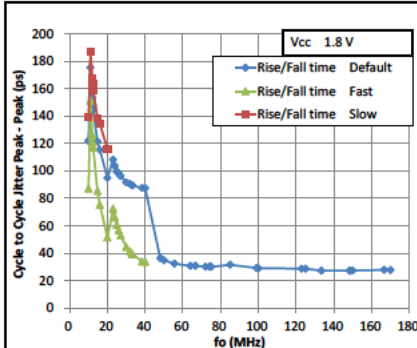

Notes:

Specification Graph

(Typical supplemental specification. Unless otherwise specified $T_{use} = 25\text{ }^{\circ}\text{C}$, $L_{CMOS} = 15\text{ pF}$, $V_{CC} = 3.3\text{ V}$)

Rise/Fall Time ($f_o = 20\text{ MHz}$)

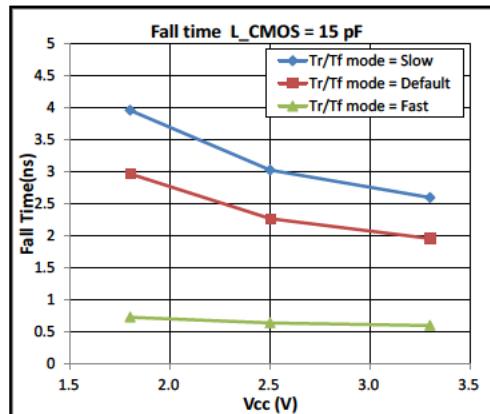
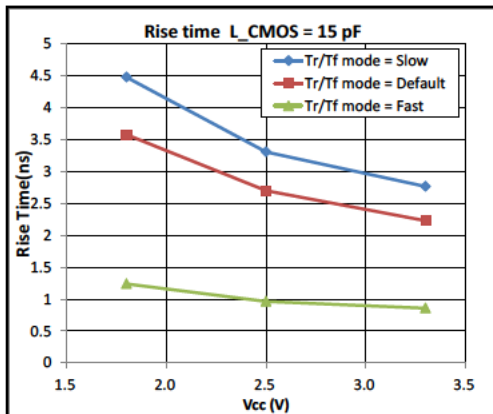
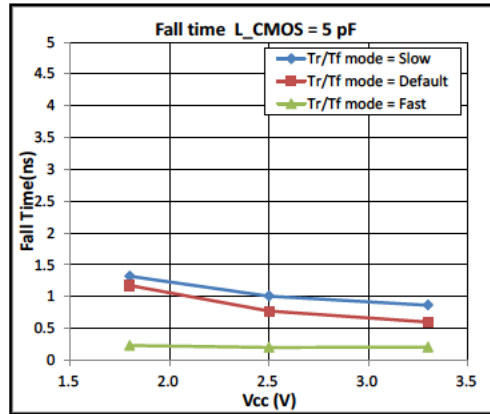
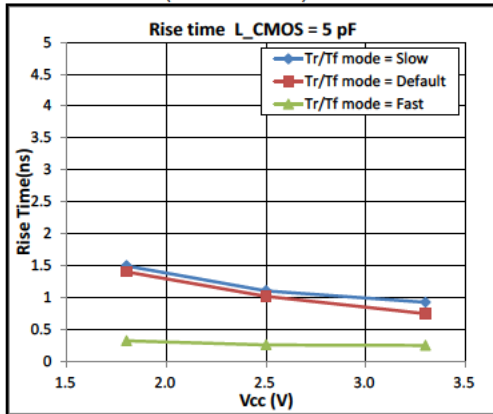

Harmonics spectrum ($f_o = 20\text{ MHz}$)

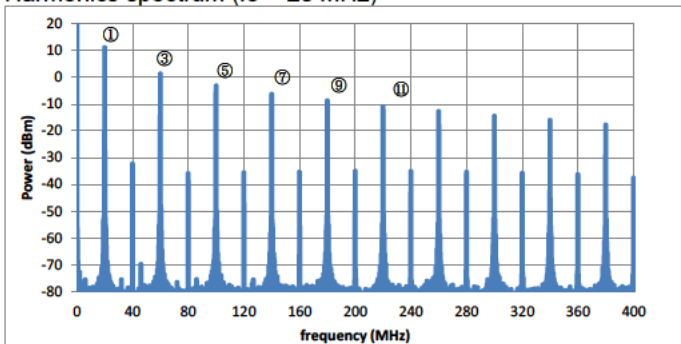

Harmonics comparison

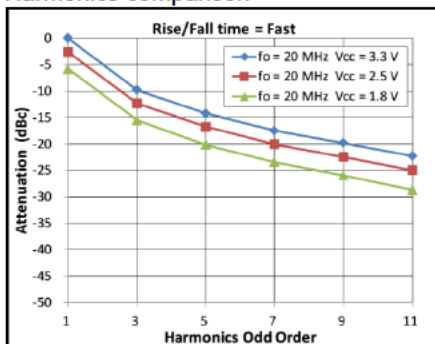

Normalize to $V_{CC} = 3.3\text{ V}$.

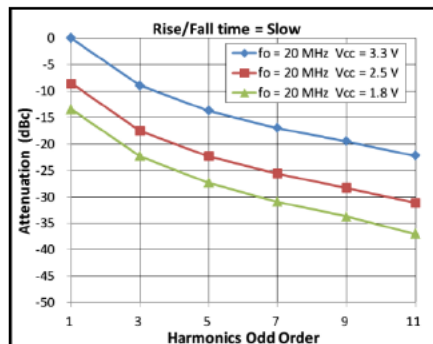

Normalize to $V_{CC} = 3.3\text{ V}$.

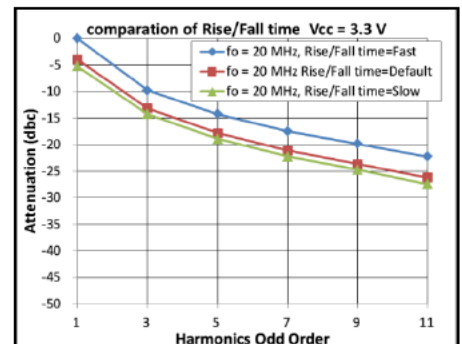

Normalize to Rise/Fall time = "Fast".

Notes:

frequency	slow	default	fast
0.67 M – 20 MHz	See Slow	See Default	See Fast
20 M – 40 MHz	-	See Default	See Fast
40 M – 170 MHz	-	See Fast	See Fast



ESD Rating

Test items	Breakdown voltage
Human Body Model (HBM)	2000 V
Machine Model (MM)	250 V
Charged Device Model (CDM)	750 V

Device Marking (Standard specification)

Factory Programmed Part Marking	Field Programmable Part Marking (Blank Samples)

Simulation Model

- IBIS Model is available upon request. Please contact us.
Information Required: Oscillator operating condition (i.e. Power Supply, Rise/Fall Time, Temperature)



Device Material & Environmental Information

Package Dimensions	# of Pins	Reference Weight (Typ.)	Terminal Material	Terminal Plating	Complies With EU RoHS	Pb Free	MSL Rating	Peak Temp. (Max)
2.5 x 2.0 x 0.7 mm	4	13 mg	W	Au	Yes	Yes	1	260°C

SMD products Reflow profile(example)

The availability of the heat resistance for reflow conditions of JEDEC-STD-020D.01 is judged individually. Please inquire.

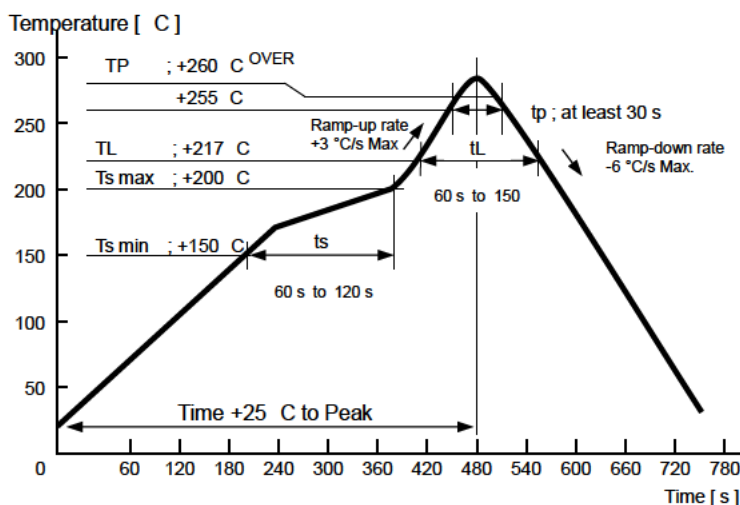

	<ul style="list-style-type: none"> Pb free.
	<ul style="list-style-type: none"> Complies with EU RoHS directive. <ul style="list-style-type: none"> About the products without the Pb-free mark. Contains Pb in products exempted by EU RoHS directive. (Contains Pb in sealing glass, high melting temperature type solder or other.)

Standard Packing Specification

SMD products are packed in the shipping carton as below table in accordance with taping standards EIA-481 and IEC-60286

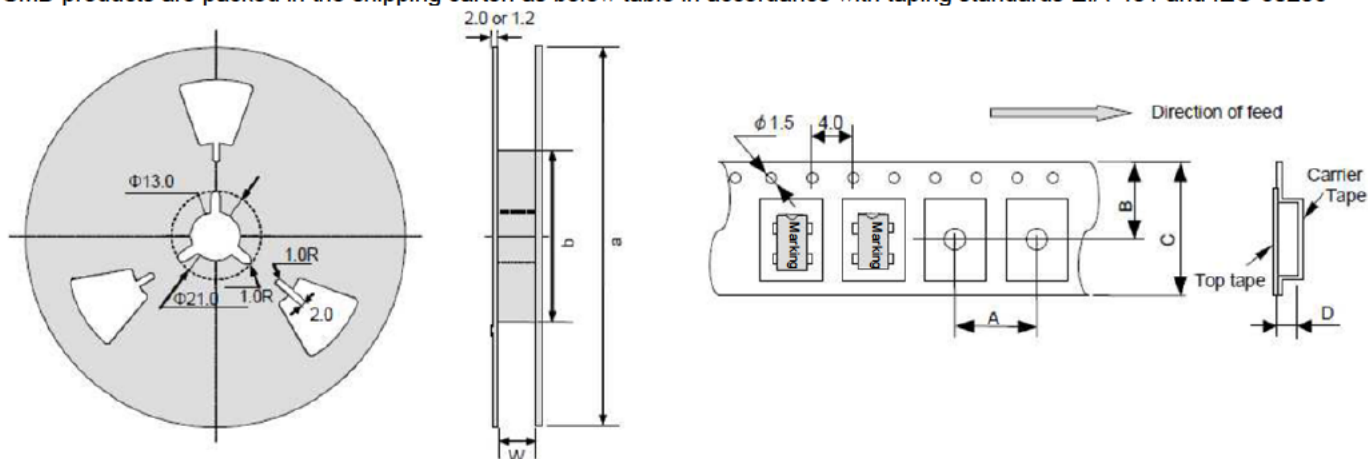

Standard Packing Quantity & Dimension(Unit mm)

Quantity (pcs/Reel)	Reel Dimension			Carrier Tape Dimension				Direction of Feed (L= Left Direction)
	a	b	W	A	B	C	D	
3000	Φ180	Φ60	9	4	5.25	8	1.15	L

PROMOTION OF ENVIRONMENTAL MANAGEMENT SYSTEM CONFORMING TO INTERNATIONAL STANDARDS

At Seiko Epson, all environmental initiatives operate under the Plan-Do-Check-Action (PDCA) cycle designed to achieve continuous improvements. The environmental management system (EMS) operates under the ISO 14001 environmental management standard.

All of our major manufacturing and non-manufacturing sites, in Japan and overseas, completed the acquisition of ISO 14001 certification.





ISO 14000 is an international standard for environmental management that was established by the International Standards Organization in 1996 against the background of growing concern regarding global warming, destruction of the ozone layer, and global deforestation.

WORKING FOR HIGH QUALITY

In order provide high quality and reliable products and services than meet customer needs, Seiko Epson made early efforts towards obtaining ISO9000 series certification and has acquired ISO9001 for all business establishments in Japan and abroad. We have also acquired IATF 16949 certification that is requested strongly by major automotive manufacturers as standard.

IATF 16949 is the international standard that added the sector-specific supplemental requirements for automotive industry based on ISO9001.

► Explanation of the mark that are using it for the catalog

	► Pb free.
	► Complies with EU RoHS directive. *About the products without the Pb-free mark. Contains Pb in products exempted by EU RoHS directive. (Contains Pb in sealing glass, high melting temperature type solder or other.)
	► Designed for automotive applications such as Car Multimedia, Body Electronics, Remote Keyless Entry etc.
	► Designed for automotive applications related to driving safety (Engine Control Unit, Air Bag, ESC etc).

NOTICE : PLEASE READ CAREFULLY BELOW BEFORE THE USE OF THIS DOCUMENT ©Seiko Epson Corporation 2020

- The content of this document is subject to change without notice. Before purchasing or using Epson products, please contact with sales representative of Seiko Epson Corporation ("Epson") for the latest information and be always sure to check the latest information published on Epson's official web sites and resources.
- This document may not be copied, reproduced, or used for any other purposes, in whole or in part, without Epson's prior consent.
- Information provided in this document including, but not limited to application circuits, programs and usage, is for reference purpose only. Epson makes no guarantees against any infringements or damages to any third parties' intellectual property rights or any other rights resulting from the information. This document does not grant you any licenses, any intellectual property rights or any other rights with respect to Epson products owned by Epson or any third parties.
- Using Epson products, you shall be responsible for safe design in your products; that is, your hardware, software, and/or systems shall be designed enough to prevent any critical harm or damages to life, health or property, even if any malfunction or failure might be caused by Epson products. In designing your products with Epson products, please be sure to check and comply with the latest information regarding Epson products (including, but not limited to this document, specifications, data sheets, manuals, and Epson's web site). Using technical contents such as product data, graphic and chart, and technical information, including programs, algorithms and application circuit examples under this document, you shall evaluate your products thoroughly both in stand-alone basis and within your overall systems. You shall be solely responsible for deciding whether to adopt/use Epson products with your products.
- Epson has prepared this document carefully to be accurate and dependable, but Epson does not guarantee that the information is always accurate and complete. Epson assumes no responsibility for any damages you incurred due to any misinformation in this document.
- No dismantling, analysis, reverse engineering, modification, alteration, adaptation, reproduction, etc., of Epson products is allowed.
- Epson products have been designed, developed and manufactured to be used in general electronic applications and specifically designated applications ("Anticipated Purpose"). Epson products are NOT intended for any use beyond the Anticipated Purpose that requires particular quality or extremely high reliability in order to refrain from causing any malfunction or failure leading to critical harm to life and health, serious property damage, or severe impact on society, including, but not limited to listed below ("Specific Purpose"). Therefore, you are strongly advised to use Epson products only for the Anticipated Purpose. Should you desire to purchase and use Epson products for Specific Purpose, Epson makes no warranty and disclaims with respect to Epson products, whether express or implied, including without limitation any implied warranty of merchantability or fitness for any Specific Purpose. Please be sure to contact our sales representative in advance, if you desire Epson products for Specific Purpose:
Space equipment (artificial satellites, rockets, etc.)/ Transportation vehicles and their control equipment (automobiles, aircraft, trains, ships, etc.) / Medical equipment/ Relay equipment to be placed on sea floor/ Power station control equipment / Disaster or crime prevention equipment/Traffic control equipment/ Financial equipment
Other applications requiring similar levels of reliability as the above
- Epson products listed in this document and our associated technologies shall not be used in any equipment or systems that laws and regulations in Japan or any other countries prohibit to manufacture, use or sell. Furthermore, Epson products and our associated technologies shall not be used for the purposes of military weapons development (e.g. mass destruction weapons), military use, or any other military applications. If exporting Epson products or our associated technologies, please be sure to comply with the Foreign Exchange and Foreign Trade Control Act in Japan, Export Administration Regulations in the U.S.A (EAR) and other export-related laws and regulations in Japan and any other countries and to follow their required procedures.
- Epson assumes no responsibility for any damages (whether direct or indirect) caused by or in relation with your non-compliance with the terms and conditions in this document or for any damages (whether direct or indirect) incurred by any third party that you give, transfer or assign Epson products.
- For more details or other concerns about this document, please contact our sales representative.
- Company names and product names listed in this document are trademarks or registered trademarks of their respective companies.